



Bigliani/Flatow[®] The Complete Shoulder Solution

4-Part Fracture of the
Humerus Surgical Technique



Replicates natural shoulder mobility, balance, and stability



Bigliani/Flatow® The Complete Shoulder Solution Surgical Technique

Table of Contents

4-Part Fracture of the Humerus Surgical Technique for Bigliani/Flatow Shoulder System

Introduction	4
Patient Positioning	5
Incision and Exposure	5
Humeral Preparation	7
Ream Humeral Canal	7
Select Humeral Head	8
Insert Stem Provisional	8
Insert Stem Provisional with (Optional) Fracture Instruments	12
Using the Ruler For Additional Height Adjustment	14
Implantation	14
Implantation Using Fracture Instruments	17
Tuberosity Reattachment	18
Closure	21
Humeral Head Removal	21
Postoperative Management	21

Introduction

A hemiarthroplasty is indicated when salvage of the native humeral head is either not possible or impractical. This is the case in most head-splitting fractures of the humeral head and in impaction fractures involving more than 40 percent of the head.

In a typical or “classic” four-part fracture (Fig. 1), the humeral head fragment is separate from the shaft and both tuberosities and is dislocated out of the glenoid. The greater and lesser tuberosities are separated from the

head fragment but may be connected to or separate from each other. The head is devoid of all soft-tissue attachment, creating a high probability of avascular necrosis. For this reason, a hemiarthroplasty is typically used in older patients. In younger patients, especially those with a “valgus impacted” pattern, internal fixation may be employed.

In a three-part fracture (Fig. 2), the head and one of the tuberosities (usually the lesser tuberosity) are together, and both are separated from the shaft and the other tuberosity. Most three-part

fractures are best treated by internal fixation. However, in some elderly patients with very osteoporotic bone, it may be difficult to achieve adequate fixation to allow early motion. In these cases, a hemiarthroplasty may be a good salvage procedure.

The goal of hemiarthroplasty for fracture is to replace the humeral head with a prosthetic component, reconstruct the rotator cuff, and reconstruct the tuberosities to both the shaft and the prosthesis.

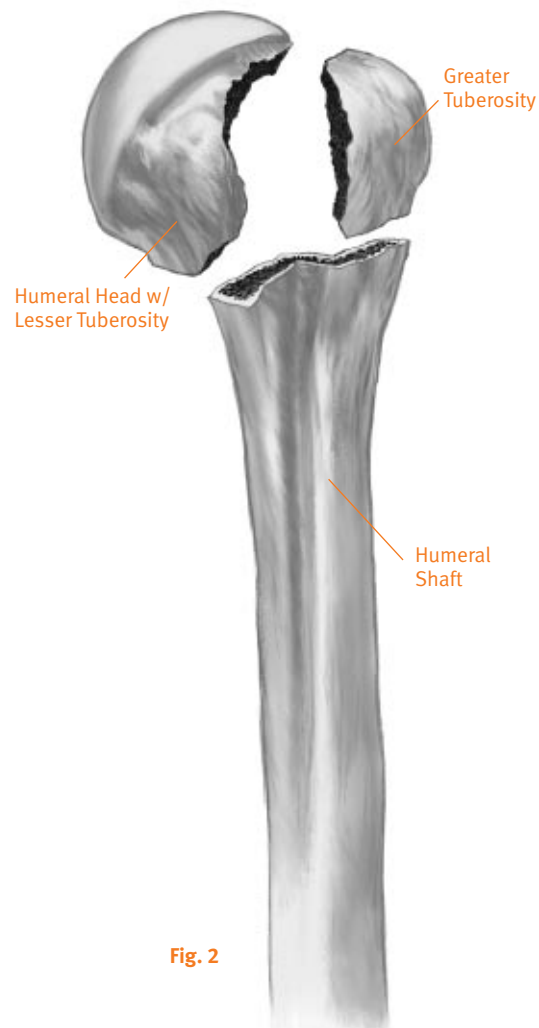
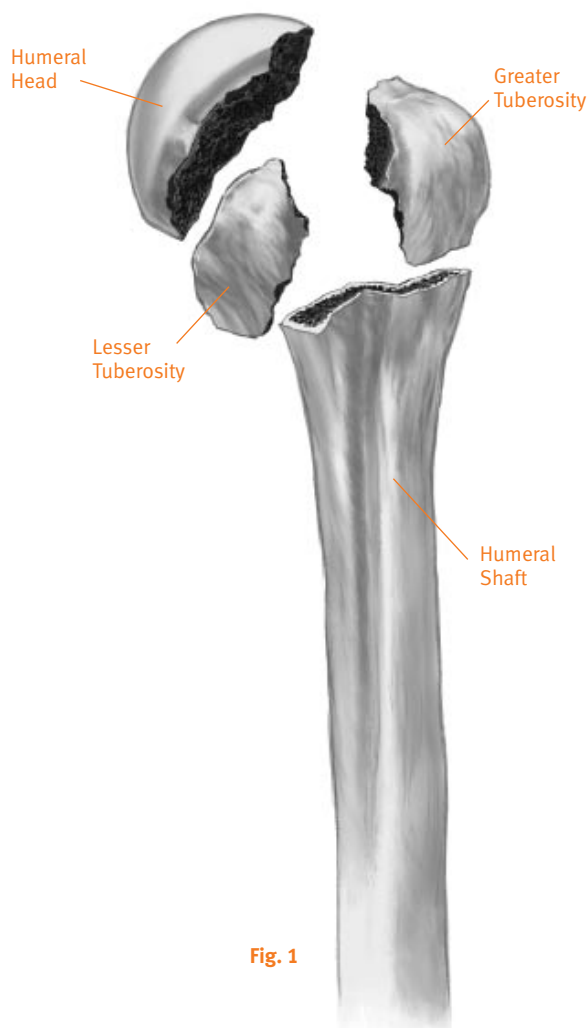

Patient Positioning

Patient positioning is especially important in shoulder surgery. Place the patient in a semi-beach-chair position with the knees flexed (Fig. 3). Raise the head of the table approximately 25-30 degrees to reduce venous pressure. Use a head rest that allows for the superior part of the table to be removed. Place two towels under the spine and the medial border of the scapula to raise the affected side. Bring the shoulder up and out. Attach a short arm board to the table, or use another arm support method that will allow the arm to be raised or lowered as necessary throughout the procedure.

Incision and Exposure

Mark the clavicle, the acromion, and the coracoid process for reference. Then mark the line of the incision, beginning at the clavicle just lateral to the coracoid process. Extend the line along the deltopectoral groove to the area of the deltoid insertion at the mid-humerus (Fig. 4).

Make the long deltopectoral skin incision following the line. Undermine the skin flaps to improve exposure. Then dissect subcutaneous tissue from the deltoid fascia, and expose the deltoid and pectoralis major muscles. Retract the skin by placing Gelpi retractors about one-third of the way down, and one-third of the way up. Develop the deltopectoral interval, retracting the pectoralis major medially and the deltoid laterally. Tie off the crossing vessels. Identify and dissect the interval between the pectoralis major muscle and the cephalic vein. Protect the cephalic vein by retracting it either medially or laterally. Retracting the vein medially will make it easier to avoid the vein when reaming. Retracting the vein

laterally will help minimize bleeding from the deltoid muscle, requiring less tying off of feeder vessels and often resulting in less swelling. Release the upper 1cm-2cm of the insertion of the pectoralis major tendon, being careful to avoid the long head of the biceps tendon. In very tight shoulders, the pectoralis

may need to be completely released. Tag the pectoralis major muscle with a suture so it can be easily identified for later reattachment. Reposition the distal medial retractor under the pectoralis major muscle.



Fig. 3

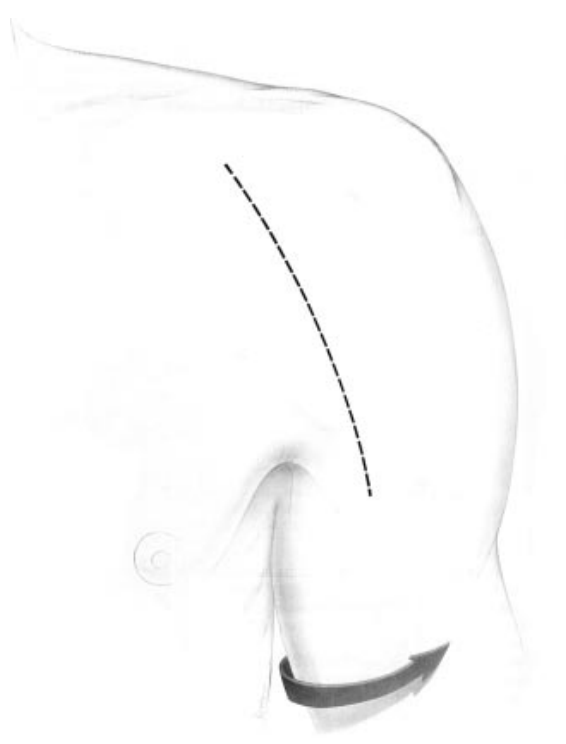

Fig. 4

Release any adhesions between the deltoid and strap muscles (coracobrachialis and short head of biceps) and develop a plane between the strap muscles and the humerus. Reposition the proximal medial retractor under the strap muscles (Fig. 5).

In approaching the fracture, both the humeral shaft and the humeral head fragments may be in a medial position which may distort the surgeon's orientation. Be careful to avoid spreading the muscular interval too far and penetrating the strap muscles. If the head is dislocated in the axilla inferior to the subscapular muscle and capsule, palpate the coracoid to determine the correct interval.

Cautious dissection is required to avoid injury to the neurovascular structures. This may require further release of the pectoralis major tendon. Careful palpation of the fragments to identify sharp edges is required to avoid neurovascular injury during removal. These patients must have careful preoperative examination.

The lesser tuberosity will be medial to the biceps tendon, and the greater tuberosity will be lateral and posterior. Tuberosity fragments can be mobilized from the shaft on either side of the bicipital groove. Remove the hemorrhagic bursa to improve the exposure.

Pass number five sutures around both the greater and lesser tuberosities to provide control of the fragments. Tie off the circumflex vessels. Then expose the humeral shaft and assess its condition.

Further release the tuberosities by dissecting soft tissue from their perimeters. If the tuberosities are still connected, they should be reattached together. If there is a crack between the tuberosities, separate them for reattachment.

If the tuberosities are already separate, divide them at the point where they are already split which is usually just lateral to the bicipital groove. Place sutures around the lesser tuberosity, and isolate it with the subscapularis attachment.

Assess the biceps tendon. If it is badly torn and frayed from contact with the sharp bone fragments, consider releasing the tendon or tendons. Some surgeons believe it can be a source of pain and may stick down in a fracture and cause stiffness. However, if the biceps groove is not involved in the fracture, the tendon can be spared.

Palpate and identify the axillary nerve beneath the subscapularis muscle to be sure that it is free and clear. Then remove capsular tissue as necessary to avoid sticking and scarring. It may be necessary to partially release the subscapularis muscle from the capsule.

In the same manner, partially release the greater tuberosity and rotator cuff from the capsular tissue. If any fragments of articular surface are still attached to the greater tuberosity, remove them with a rongeur. Pass sutures around the greater tuberosity, and isolate it with the rotator cuff attachments.

With the tuberosities retracted, suction the humeral canal.

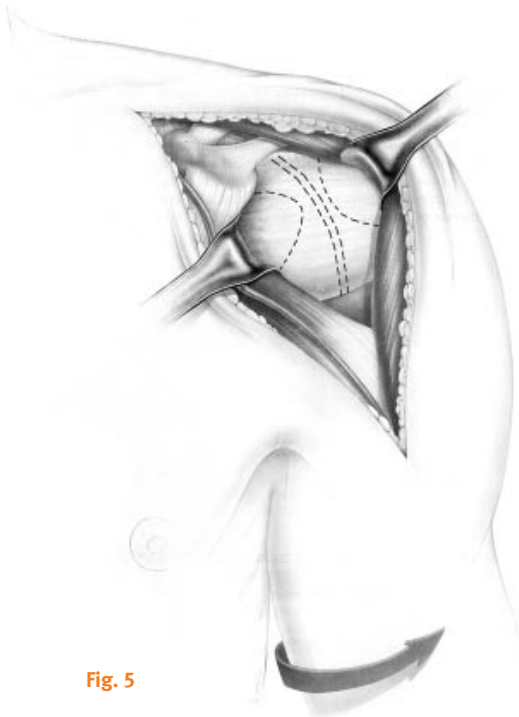

Fig. 5

Humeral Preparation

The goal of humeral preparation is to place a prosthetic articular surface precisely on the proximal humerus as it was before the fracture. The relationship among bony anatomy, rotator cuff insertions, and soft tissue tension must all be considered.

Ream Humeral Canal

Attach the Ratchet T-handle to the appropriate size blunt-tipped Intramedullary Tapered Reamer. There are three positions marked on the collar of the T-handle—FORWARD, LOCKED, and REVERSE. Set the instrument to the FORWARD position (Fig. 6), and begin manually reaming the humeral canal (Fig. 7).



Fig. 6

Use progressively larger reamers in one-millimeter increments until resistance is felt from cortical contact in the canal. Continue reaming to the appropriate depth as indicated on the reamer shaft. The depth corresponds to the implant length chosen. Do not remove cortical bone. These reamers have blunt tips to help guide them down the canal and prevent obstruction into cortical bone. Remove the Ratchet T-handle and reamer.

Note: If using a 60mm length stem, use only the Short Intramedullary Reamers. Use the Intramedullary Tapered Reamers for 110mm monoblock stems. Ream until the flutes are buried in the bone.



Fig. 7

Select Humeral Head

Standard or offset heads are available. Choose the size of the humeral head component by comparing the Humeral Head Provisional with the humeral head fragment (Fig. 8). Then attach the selected head provisional to the Humeral Stem Provisional and again compare it side by side to the humeral head fragment (Fig. 9). Remove the head provisional.



Fig. 8



Fig. 9

Insert Stem Provisional

Use the Wrench handle through one of the holes to tighten the white plastic cap on the Humeral Stem Inserter/Extractor. Attach the selected Humeral Stem Provisional to the inserter/extractor and tighten the thumb screw. (The Humeral Stem Provisional is typically the same size as the largest reamer used.)

In most fractures, the humeral head will break off cleanly from the medial calcar, leaving a sufficient amount of calcar to determine the appropriate height of the component. If this is the case, assess the proper height and retroversion of the prosthetic components by holding the humeral head fragment in its normal position on the humeral shaft (Fig. 10). Then insert the Humeral Stem Provisional into the canal until the collar contacts the remaining calcar (Fig. 11). Select a prosthetic head that is close in size and curvature to the one removed.



Fig. 10



Fig. 11

If the calcar is fragmented or no calcar remains, determine the appropriate height by reducing the tuberosity fragments relative to the diaphysis and adjusting the height of the humeral component so that the tuberosities are just tucked in under the collar (Fig. 12). Establishing height is facilitated if there is a large spike on the greater tuberosity that “keys” in on a defect. The humeral head is typically placed two to three millimeters above the keyed-in greater tuberosity. The tuberosity fragments should overlap the metaphyseal fragment by about 5mm so bony union can be achieved. Measure the distance between the diaphyseal fracture line and the collar of the humeral stem (Fig. 13).



Fig. 12

Another way to determine prosthetic height is to select a head height that allows for appropriate laxity. Remove the Humeral Stem Inserter/ Extractor and attach the selected Humeral Head Provisional. Insert a metallic Capture Pin into the head provisional (Fig. 14). Reduce the joint, and check the laxity by attempting to translate the head. The desired laxity is achieved when light pressure translates the head about 50 percent of its diameter posteriorly and inferiorly. Mark the position of the fin on the bone, and note the height relative to the shaft. Then remove the Humeral Head Provisional. Use these references to guide the placement of the final implants so this position is reproduced.

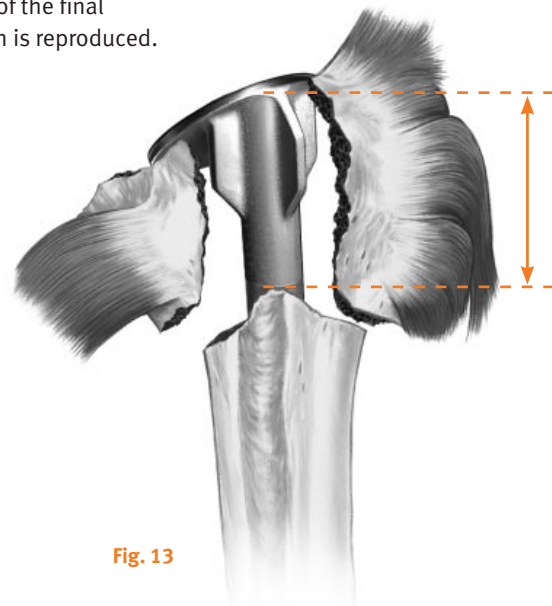

Fig. 13

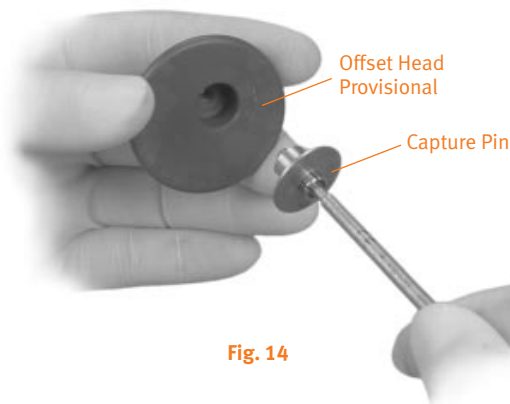

Fig. 14

Use the Alignment Pins to verify stem retroversion. This is especially helpful in fracture cases where the bony landmarks are compromised. Reattach the Humeral Stem Inserter/Extractor. There are 20-degree and 40-degree holes on the inserter/extractor to accept the Alignment Pins. With the elbow flexed 90 degrees, insert the pins into the holes and line up the pins with the forearm to assess retroversion. The forearm should be between the 20-degree and 40-degree pins (Fig. 15).

In neutral alignment, the handle of the inserter/ extractor will be perpendicular to the forearm. As the handle is rotated posteriorly, the degree of retroversion will increase to 40 degrees when the 40-degree line for that arm is parallel to the forearm. In a fracture, slightly less retroversion (usually about 20 degrees) is suggested to help relieve tension on the reattached greater tuberosity in internal rotation (Fig. 16).



Fig. 16

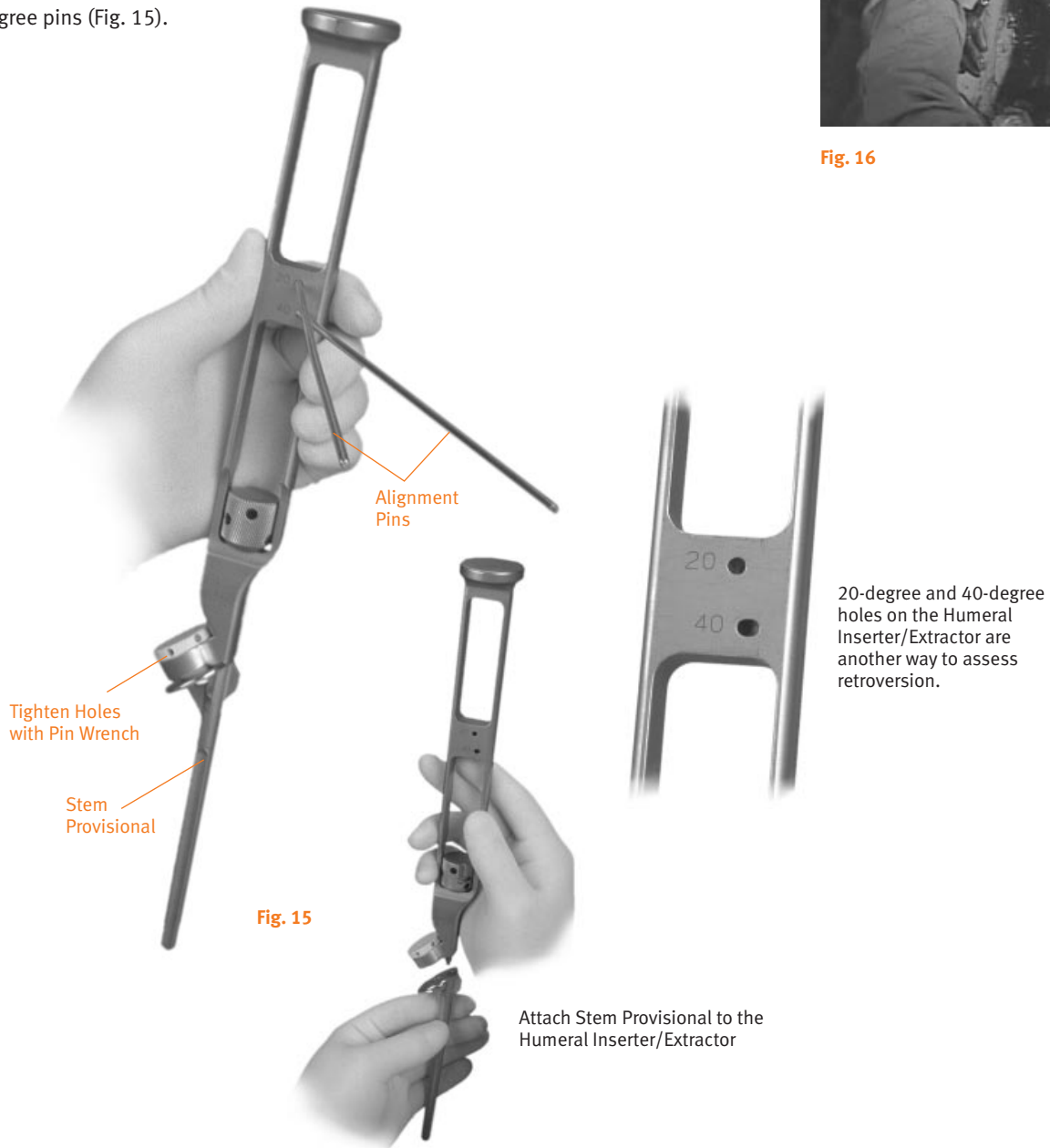

Fig. 15

Attach Stem Provisional to the Humeral Inserter/Extractor

Remove the Humeral Stem Inserter/ Extractor and reattach the selected Humeral Head Provisional to the Humeral Stem Provisional, using the Capture Pin. If the anatomy places the collar of the Humeral Stem Provisional eccentrically, the humeral head will place asymmetric tension on the rotator cuff. This may suggest the use of an offset head. Adjust the offset by rotating the head until it sits anatomically on the medial calcar. Ideal placement of the humeral head will be achieved when the head is centered relative to the rotator cuff (Fig. 17).



Fig. 17

As a point of reference, note which etch mark on the clock face of the Offset Humeral Head Provisional lines up with the lateral fin of the Humeral Stem Provisional (Fig.18).

Reduce the joint and perform a trial range of motion. Then remove the provisional components.

Drill two holes through the wall of the humeral shaft medial to the biceps groove. Then drill three or four holes through the shaft lateral to the biceps groove. Insert a number five and a number two suture through each hole.

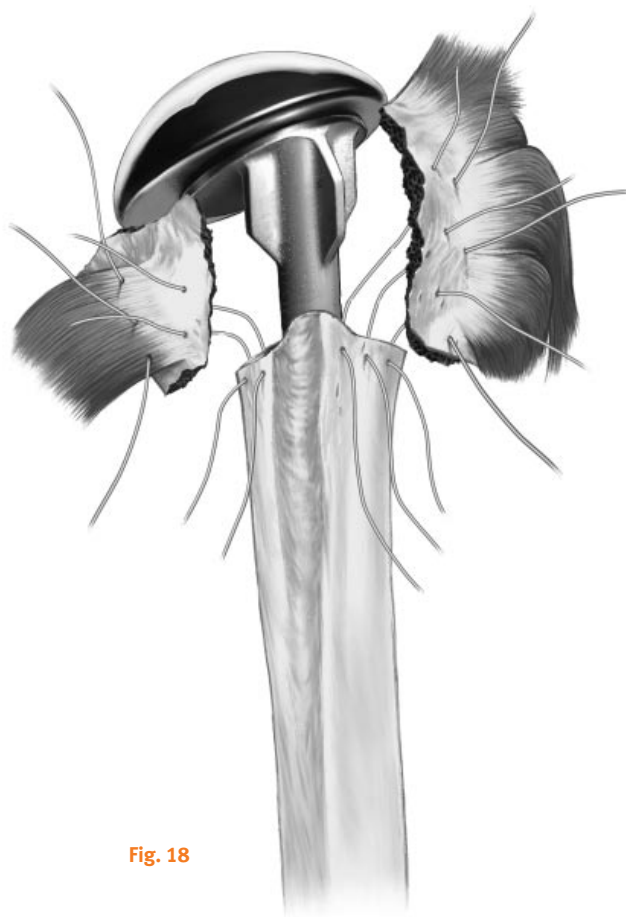

Fig. 18

Insert Stem Provisional with (Optional) Fracture Instruments

Assemble appropriate sized foam sleeve with desired provisional stem size. The sleeves are available in four sizes: Small, Medium, Large, and Extra-Large. Sleeve size determination is based on provisional stem size.

Sleeve Size	Provisional Size
Small	6mm-8mm
Medium	9mm-11mm
Large	12mm-14mm
X-Large	>15mm

Note: Choose the stem provisional two (2) sizes down from the reamed diameter. Then apply the corresponding sleeve.

The sleeves are designed to fit snugly on the distal portion of the provisional humeral stem to help assess axial height and provide additional stabilization in the canal. One of each size is included in a sterile package (00-4303-007-00) (Fig. 19).



Fig. 19

The universal fin clamp places the bottom of the clamp approximately 18mm below the zero point of the stem as referenced on the surgical templates (Fig. 20).

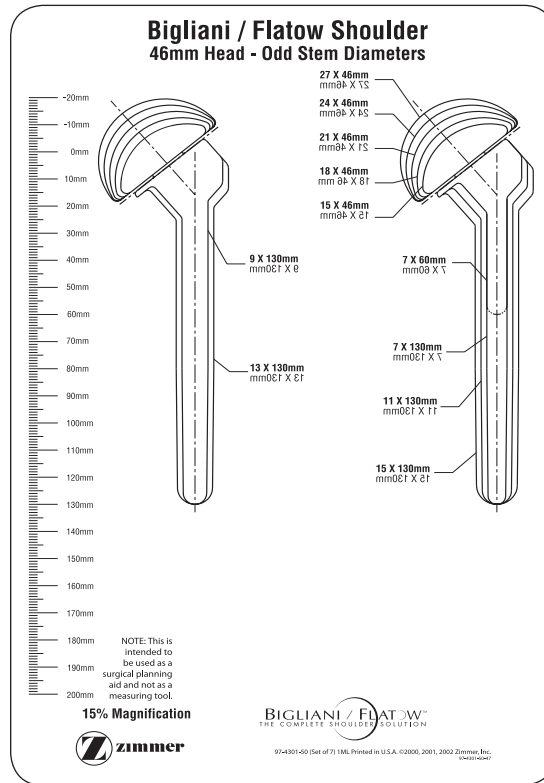

To move the stem up or down by 3mm, change to the appropriate Right or Left fin clamp. For example: *To lower a left shoulder, use the Left 21, R15 fin clamp* (Fig. 21).

Fin Clamp	Function
R15	Lowers Right Provisional 3mm,
L21	Raises Left Provisional 3mm
L15	Lowers Left Provisional 3mm,
R21	Raises Right Provisional 3mm



Fig. 21

Attach universal fin clamp to anterior fin of the provisional stem utilizing the pin wrench. It is used for both the right or left shoulder. The appropriate L or R will be facing up in the proper position.

The hex screw must be placed in the top threaded hole for correct attachment to the stem provisional. Insert provisional fin clamp construct into the humeral canal (Fig. 22).

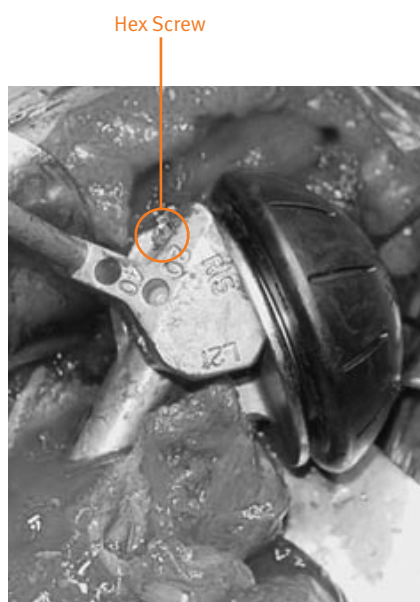

Fig. 22

Insert alignment rods into fin clamp (Fig 23). Adjust retroversion using the forearm as a reference. The forearm should be between the alignment rods and closer to the 20-degree rod. Humeral stems are commonly placed more toward 20 degrees of retroversion to aid fracture and subscapularis healing.



Fig. 23

Assess the height of the humeral provisional using the bottom edge of the fin clamp as a reference to the fracture surface (Fig. 24).

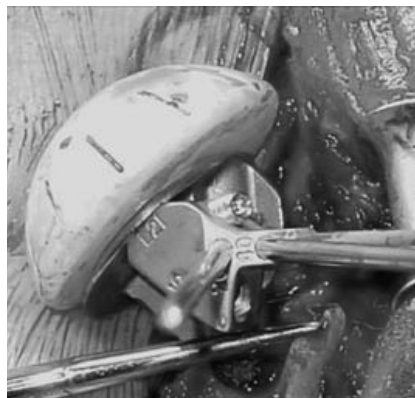

Fig. 24

Reduce the joint and perform a range of motion assessment. The tuberosities can now be brought around to confirm proper positioning (Fig. 25).



Fig. 25

Using the Ruler for Additional Height Adjustment

Assemble the ruler to the fin clamp by sliding it over the arm of the fin clamp until it is fully seated against the bone. Tighten it using the screw (Fig. 26).

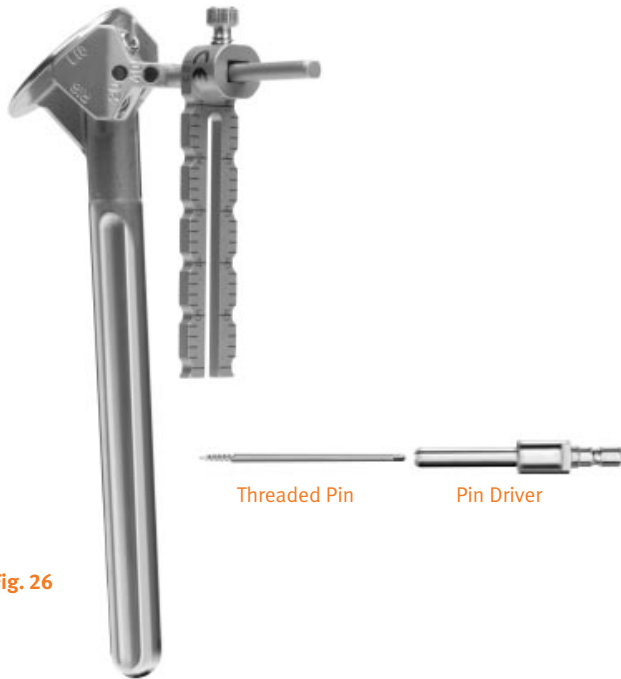

Fig. 26

When stem provisional position is set, mark the position of the fin clamp on the bone surface as it relates to the ruler by inserting the 3.2mm threaded pin(s) in the central slot of the ruler with the Pin Driver.

Implantation

The *Bigliani/Flatow* Humeral Component is available in both monoblock and modular options. If using the modular option with a standard humeral head, attach the humeral head component to the taper of the humeral stem component. Place the assembled components into the impaction stand, apply the head pusher to the head, and impact it with a mallet (Fig. 27).

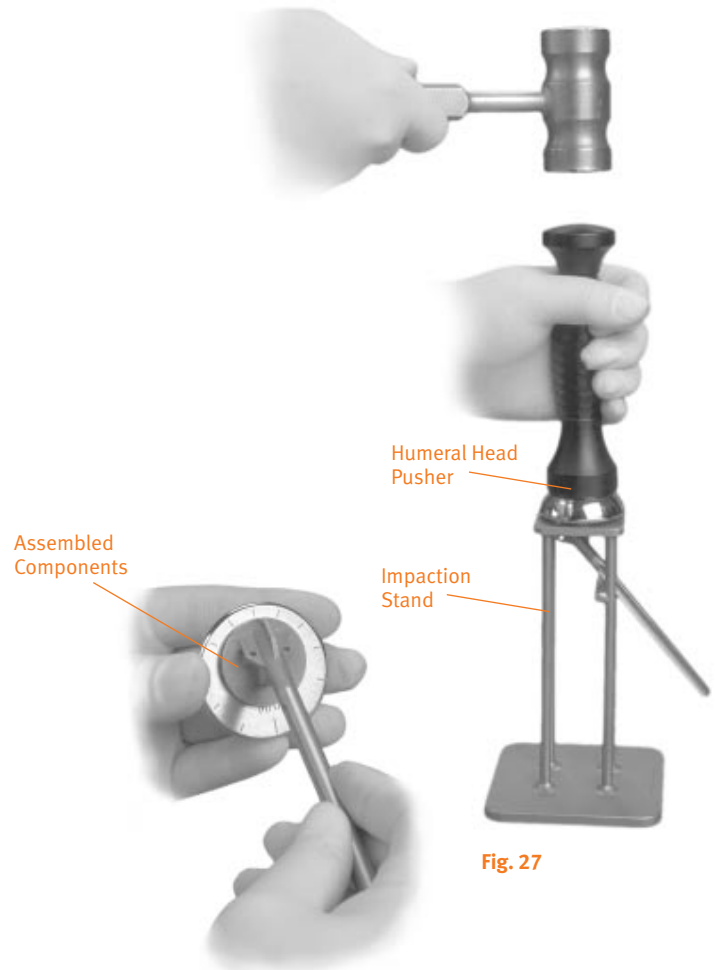

Fig. 27

If using an offset humeral head, there are two ways to attach the humeral head component to the humeral stem component. One way is to hold the humeral head component so that the clock face on the inferior side is visible. These etch marks correspond to those on the Humeral Head Provisional. Place the taper of the humeral stem component into the hole so that the lateral fin is at the previously determined reference point on the clock face (Fig. 28). Then place the assembled components into the impaction stand, apply the head pusher to the head, and impact it with a mallet.

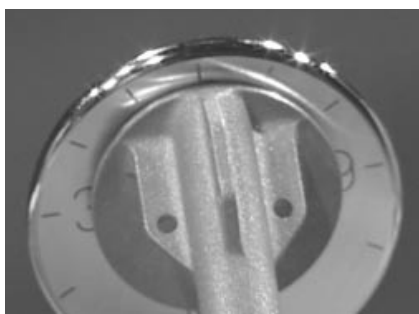

Fig. 28

Another way is to first insert the humeral stem component into the impaction stand. Attach the offset humeral head component to the Offset Humeral Head Inserter so that the single prong is positioned at the previously determined reference point on the clock face (Fig. 29). Then place the head on the stem so the mark is in line with the lateral fin. Remove the Offset Humeral Head Inserter, apply the head pusher to the head, and impact it with a mallet.

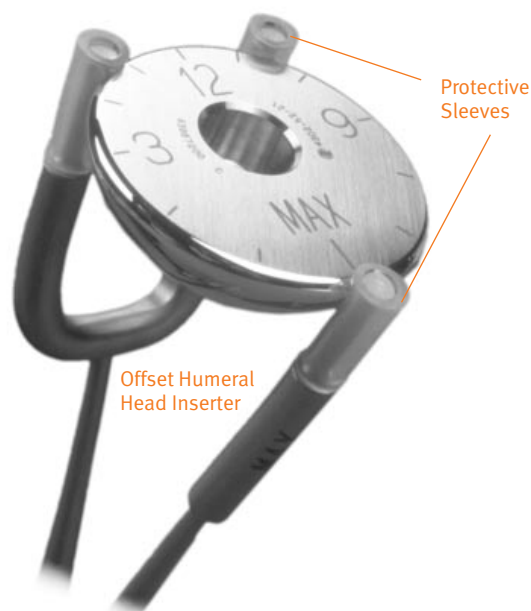

Fig. 29

Before injecting cement into the canal, insert the final assembled components or monoblock stem and check their final position and fit. Remove the components, and thoroughly clean and dry the humeral canal. Then inject cement into the canal. Use a finger to thoroughly pack the cement. Make sure that the humeral stem taper is clean. Insert the assembled components or monoblock stem into the canal until the collar contacts any remaining calcar (Fig. 30).



Fig. 30

If no calcar remains, insert the stem so the collar is at the predetermined height above the diaphyseal fracture line (Fig. 31).

Make certain that there is no excess cement extruding from the canal proximally above the humeral stem into the fracture site. This will interfere with the potential for bony union between the tuberosities and the diaphyseal fragment. Use a curette to remove any excess cement and to remove cement from the upper one centimeter of the shaft to leave room for bone graft. It is important to keep the heavy nylon sutures separated to avoid confusion in tying the proper sutures.

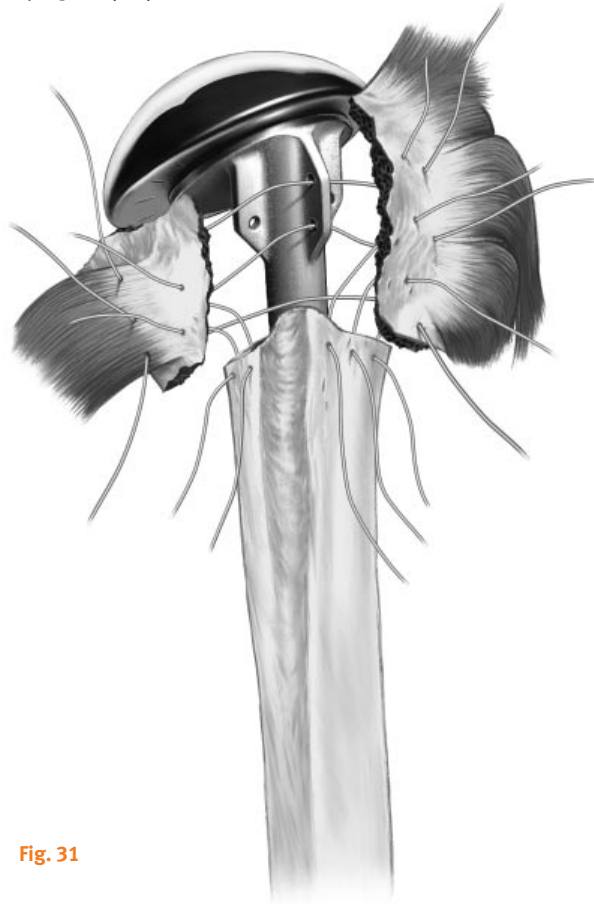

Fig. 31

Implantation Using Fracture Instruments

Remove provisional stem and discard foam sleeve. Do not use the tether to remove provisional stem. Loosen the ruler and then fin clamp with pin wrench.

Note: Foam sleeves are not to be used for implantation or with the humeral implant.

Attach the fin clamp to the anterior fin of the implant (Fig. 32).

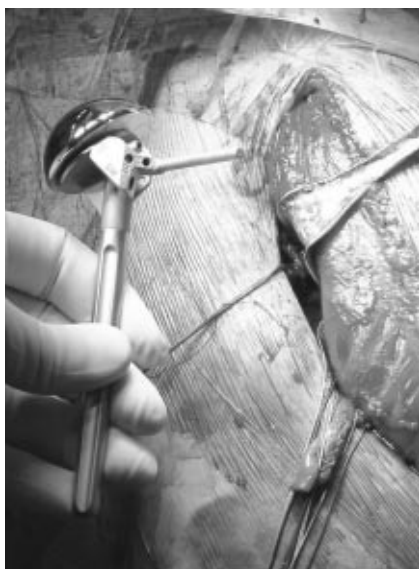

Fig. 32

Insert bone cement into humeral canal. Attach the fin clamp to the desired implant using the clamp's arm for alignment and as a handle for the prothesis. Insert the implant into the canal (Fig. 33) to the level established with the provisional. The humeral head implant or humeral head provisional may be attached if desired. Reaffirm axial height and retroversion alignment prior to cement curing (Fig. 34).

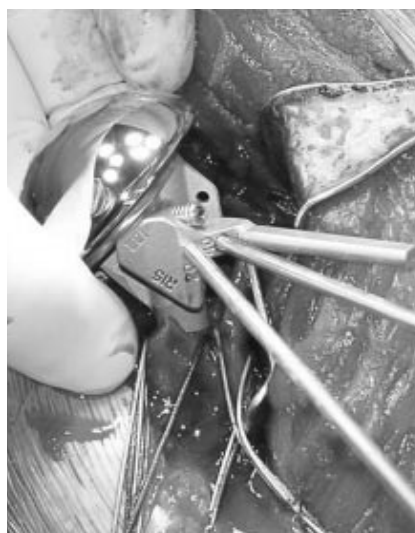

Fig. 33



Fig. 34

Note: Avoid cementing fin clamp in place by removing any bone cement in contact with the fin clamp prior to curing.

If using the ruler, slide it onto the fin clamp and align the implant to the position marked on the bone. If the pins have also been used, slide the implant down over the pin(s) to the desired level.

Remove ruler and fin clamp from implant.

Remove the pin(s) from the humerus with the Pin Driver.

Remove any excess bone cement and assure that the implant is clean prior to placement of the humeral head. Impact humeral head implant if necessary.

Perform final range of motion assessment.

Tuberosity Reattachment

After the cement has hardened, use cancellous bone from the retrieved humeral head to graft the upper shaft and the area around the prosthesis where the tuberosities will be reattached.

Place heavy nylon sutures (#5 or #2) transversely through the tuberosities and the holes in the humeral component in such a way that, when tied, the tuberosities reduce and remain stable below the humeral head (Fig. 35).

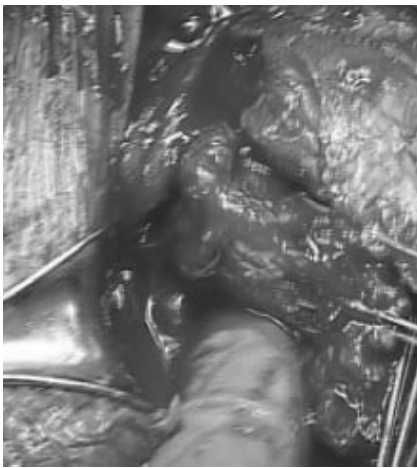

Fig. 35

The vertical heavy nylon sutures must also be used through the proximal humerus to reinforce the reconstruction and ensure that the tuberosities do not migrate proximally. The vertical sutures also maintain the tuberosities in an overlap configuration relative to the shaft so that bony union can take place. There should be two vertical sutures medial to the bicipital groove for the lesser tuberosity and three to four vertical sutures lateral to the bicipital groove for the greater tuberosity. These must be placed prior to cementing the humeral stem. The vertical sutures should be tied first, followed by the transverse sutures (Fig. 36).

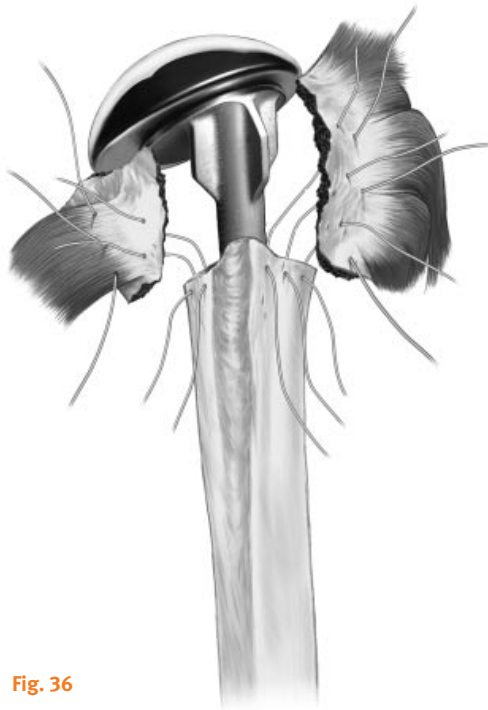

Fig. 36

The primary goal of tuberosity fixation is to get a stable overlapping fit of the tuberosity to the proximal humeral shaft as this is where union will occur.

Use the sutures to reduce and stabilize the greater tuberosity by maneuvering it around the prosthesis and into the proper position (Fig. 37). Then use the sutures to maneuver and reduce the lesser tuberosity (Fig. 38). If the tuberosities seem bulky, use a rongeur to remove any bone that obstructs a keyed fit of the fragments.



Fig. 37

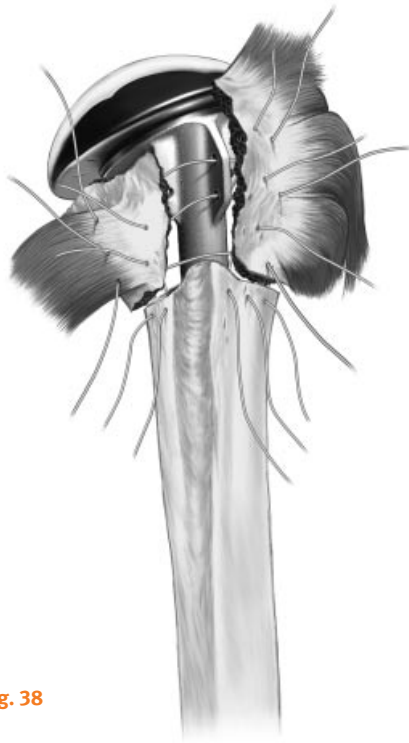

Fig. 38

If additional fixation is needed, pass a *Cable-Ready*® Cable Grip System cable inferiorly to superiorly around the rotator cuff insertion into the greater tuberosity (Fig. 39). Cross the cable inferiorly and pass it inferiorly to superiorly around the subscapularis insertion into the lesser tuberosity (Fig. 40). Then tension the cable as desired and crimp it (Fig. 41).

Check stability and range of motion (Fig. 42). If necessary, add bone graft to fill gaps (Fig. 43).



Fig. 41

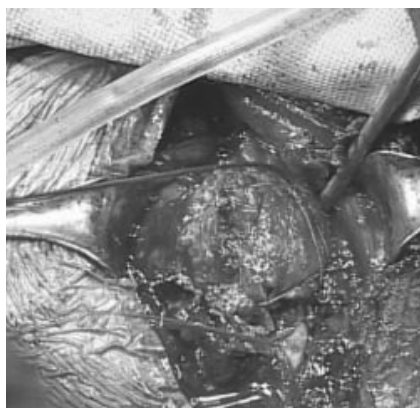

Fig. 39

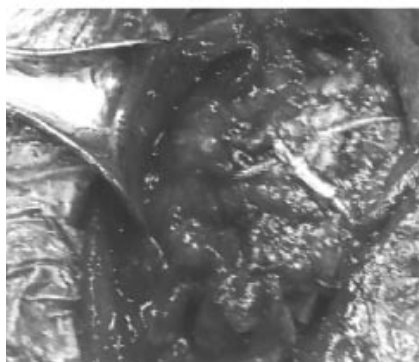

Fig. 42



Fig. 40



Fig. 43

Closure

If the biceps tendon was released, suture it to the pectoralis tendon. Then irrigate the wound and insert a *Hemovac*® Wound Drainage Device, being careful to avoid the axillary nerve. Close the subcutaneous layers and then the skin.



Pre-Op



Post-Op

Humeral Head Removal

Should a humeral head ever have to be removed, slide the Head Distractor between the collar of the humeral stem and the undersurface of the humeral head (Fig. 45). Firmly tap the end of the instrument to loosen the head. This instrument can be used to remove either provisional heads or implants.



Fig. 45

Postoperative Management

On the first postoperative day, the patient typically begins hand and elbow motion and passive shoulder range of motion. This should include pendulum exercises, elevation exercises, and external rotation exercises with a stick in the supine position and the arm slightly abducted. Passive elevation in the plane of the scapula is performed by the surgeon, a therapist, or a trained family member to a predetermined limit. The limits of postoperative motion are determined intraoperatively.

If the tuberosities are fragmented and osteoporotic, elevation in the scapular plane should be limited to about 90 or 100 degrees, and gentle external rotation is allowed to about 10 or 20 degrees. If the tuberosity repair is more secure, elevation to 140 degrees and external rotation to 40 degrees may be allowed. Motion is passive, and pulley exercises are usually avoided as these tend to cause some active use of the rotator cuff. Internal rotation, which can add tension to the greater tuberosity repair, should be avoided. The patient is typically discharged two to four days after surgery, but should continue exercises as an outpatient. At six to eight weeks, when some tuberosity healing is evident on radiographs, active exercises can begin, as well as increased range of motion stretches, including internal rotation.

Resistive strengthening exercises are gradually added. These exercises should emphasize stretching and balancing the range of motion. Strengthening is a secondary concern that need not be achieved until several months postoperatively.

Case Layouts

Bigliani-Flatow The Complete Shoulder Solution Humeral Top Tray Instruments

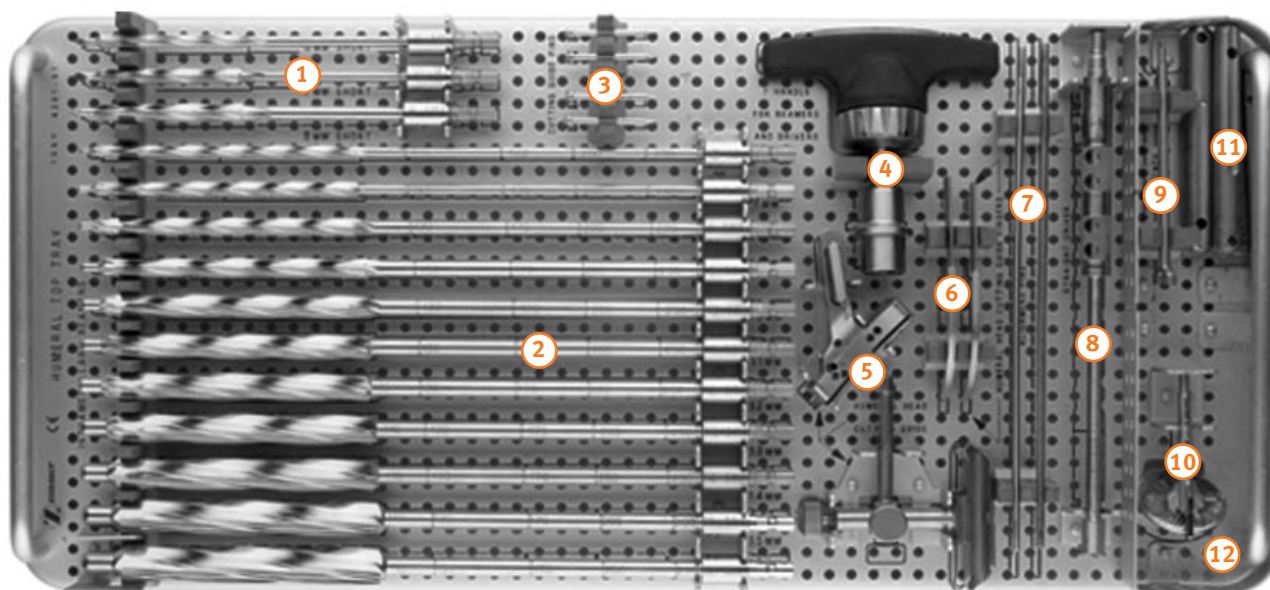

Kit 00-4300-000-13 Humeral General Instruments

- | | |
|--|--|
| <p>1 00-4301-006-01 Intramedullary Reamer, Short, 6mm
00-4301-007-01 Intramedullary Reamer, Short, 7mm
00-4301-008-01 Intramedullary Reamer, Short, 8mm</p> <p>2 00-4301-006-00 Intramedullary Reamer, Blunt Tip, 6mm
00-4301-007-00 Intramedullary Reamer, Blunt Tip, 7mm
00-4301-008-00 Intramedullary Reamer, Blunt Tip, 8mm
00-4301-009-00 Intramedullary Reamer, Blunt Tip, 9mm
00-4301-010-00 Intramedullary Reamer, Blunt Tip, 10mm
00-4301-011-00 Intramedullary Reamer, Blunt Tip, 11mm
00-4301-012-00 Intramedullary Reamer, Blunt Tip, 12mm
00-4301-013-00 Intramedullary Reamer, Blunt Tip, 13mm
00-4301-014-00 Intramedullary Reamer, Blunt Tip, 14mm
00-4301-015-00 Intramedullary Reamer, Blunt Tip, 15mm
00-4301-016-00 Intramedullary Reamer, Blunt Tip, 16mm</p> <p>3 00-5977-056-01 Cutting Guide Pins</p> | <p>4 00-4301-004-00 T-Handle (for Reamers and Drivers)</p> <p>5 00-4301-001-00 Humeral Head Cutting Guide</p> <p>6 00-4301-001-09 Humeral Head Cutting Guide Fingers</p> <p>7 00-4301-002-03 Alignment Pins</p> <p>8 00-4301-073-00 Straight Driver</p> <p>9 00-4301-033-00 Wrench</p> <p>10 00-4301-074-00 Stem Collar Counterbore, 6mm-7mm</p> <p>11 00-4301-074-08 ICounterbore Stem Extension, 8mm-9mm
00-4301-074-10 ICounterbore Stem Extension, 10mm-11mm
00-4301-074-12 ICounterbore Stem Extension, 12mm-13mm
00-4301-074-14 ICounterbore Stem Extension, 14mm-16mm</p> <p>12 00-4301-090-00 IHumeral Instrument/Provisional Case (empty)
(includes lid, three tray inserts, and base)</p> |
|--|--|

Case Layouts

Bigliani-Flatow The Complete Shoulder Solution Humeral Middle Tray Instruments

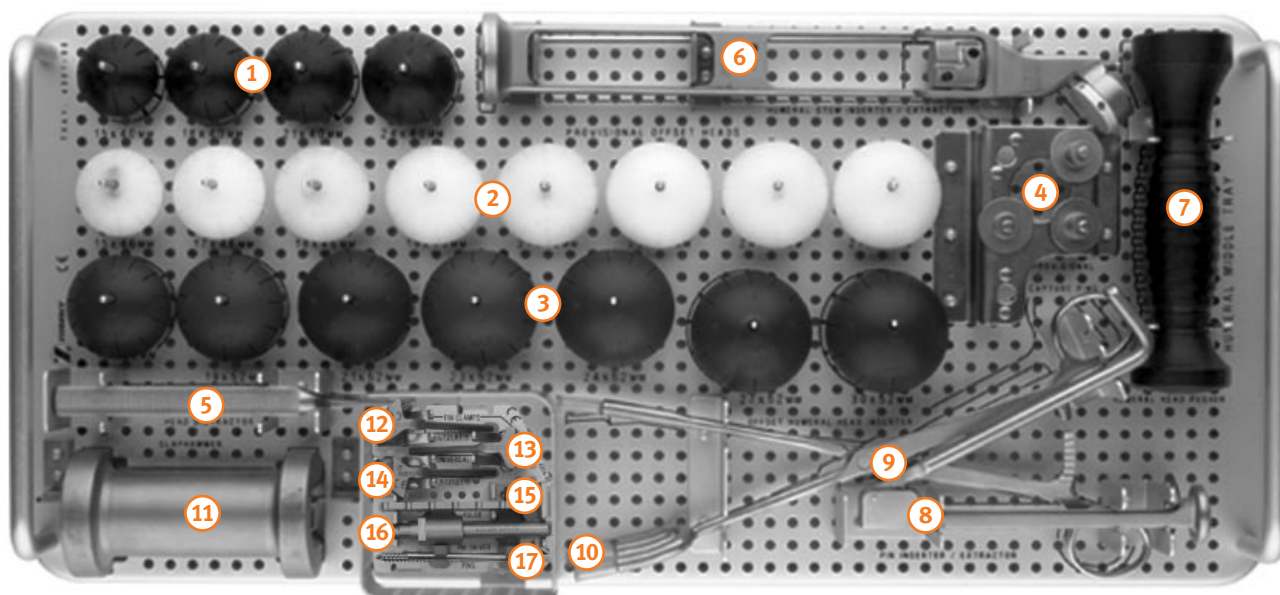

Kit 00-4300-000-12 Offset Head Provisionals

- 1** 00-4303-040-15 Provisional Offset Head, 15mm x 40mm
- 00-4303-040-18 Provisional Offset Head, 18mm x 40mm
- 00-4303-040-21 Provisional Offset Head, 21mm x 40mm
- 00-4303-040-24 Provisional Offset Head, 24mm x 40mm
- 2** 00-4304-046-15 Provisional Offset Head, 15mm x 46mm
- 00-4304-046-17 Provisional Offset Head, 17mm x 46mm
- 00-4304-046-18 Provisional Offset Head, 18mm x 46mm
- 00-4304-046-19 Provisional Offset Head, 19mm x 46mm
- 00-4304-046-21 Provisional Offset Head, 21mm x 46mm
- 00-4304-046-23 Provisional Offset Head, 23mm x 46mm
- 00-4304-046-24 Provisional Offset Head, 24mm x 46mm
- 00-4304-046-27 Provisional Offset Head, 27mm x 46mm
- 3** 00-4303-052-18 Provisional Offset Head, 18mm x 52mm
- 00-4303-052-19 Provisional Offset Head, 19mm x 52mm
- 00-4303-052-21 Provisional Offset Head, 21mm x 52mm
- 00-4303-052-23 Provisional Offset Head, 23mm x 52mm
- 00-4303-052-24 Provisional Offset Head, 24mm x 52mm
- 00-4303-052-27 Provisional Offset Head, 27mm x 52mm
- 00-4303-052-30 Provisional Offset Head, 30mm x 52mm
- 4** 00-4303-054-00 Provisional Capture Pins

Kit 00-4300-000-13 Humeral General Instruments

- 5** 00-8543-001-02 Head Distractor
- 6** 00-4301-002-00 Humeral Stem Inserter/Extractor
- 7** 00-4301-002-00 Humeral Head Pusher
- 8** 00-4305-030-20 Pin Inserter/Extractor

Kit 00-4302-000-11 Offset Head Instruments

- 9** 00-4303-075-00 Offset Humeral Head Inserter
- 10** 00-4303-075-01 Protective Sleeves
- 11** 00-6601-004-00* Slaphammer

Kit 00-4304-000-00 Fracture Instruments

- 12** 00-4304-005-00 Fin Clamp Left 21, Right 15
- 13** 00-4304-004-00 Fin Clamp Universal
- 14** 00-4304-006-00 Fin Clamp Right 21, Left 15
- 15** 00-4304-002-00 Ruler
- 16** 00-4304-009-00 Pin Driver
- 17** 00-4304-008-00 3.2mm Threaded Pins
- 00-4304-090-00 Instrument Tray Insert (empty)
- 00-4304-007-00 Fracture Sleeves (not pictured)
- 00-4304-010-00 Locking Screw (not pictured)

*Must be ordered separately

Case Layouts

Bigliani-Flatow The Complete Shoulder Solution Humeral Bottom Tray Instruments

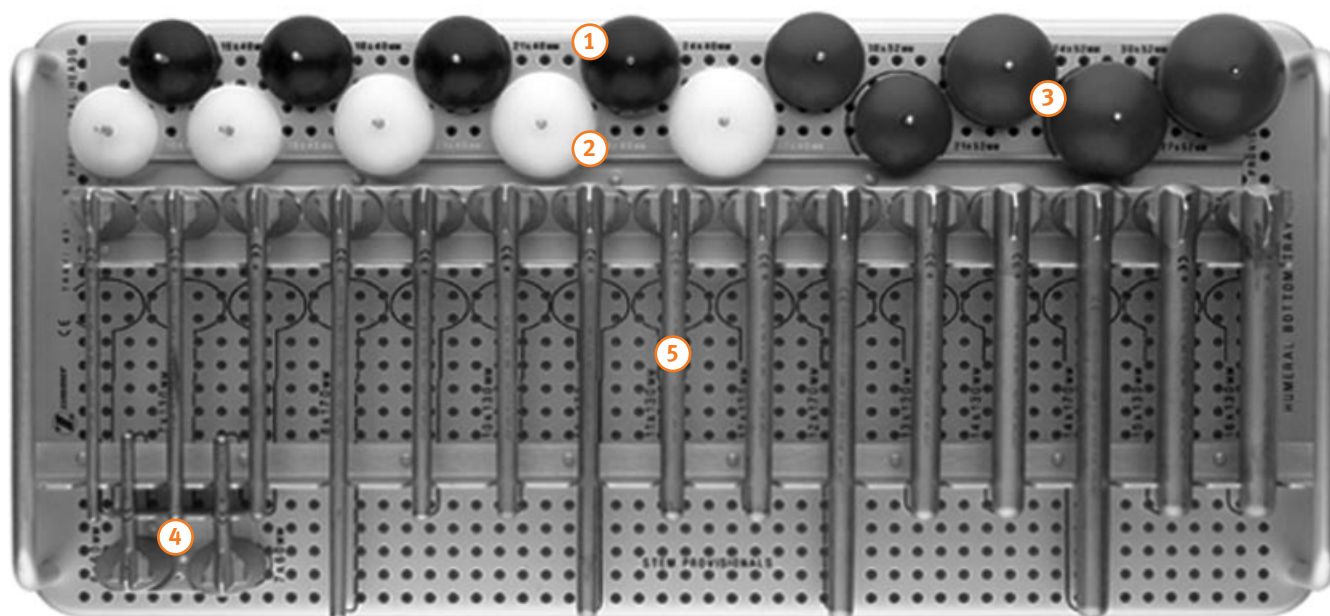

Kit 00-4300-000-17 Standard Head Provisionals

- | | | |
|----------|----------------|-------------------------------|
| 1 | 00-4301-040-15 | Provisional Head, 15mm x 40mm |
| | 00-4301-041-18 | Provisional Head, 15mm x 40mm |
| | 00-4301-041-21 | Provisional Head, 21mm x 40mm |
| | 00-4301-041-24 | Provisional Head, 24mm x 40mm |
| 2 | 00-4301-046-15 | Provisional Head, 15mm x 46mm |
| | 00-4301-046-18 | Provisional Head, 18mm x 46mm |
| | 00-4301-046-21 | Provisional Head, 21mm x 46mm |
| | 00-4301-046-24 | Provisional Head, 24mm x 46mm |
| | 00-4301-046-27 | Provisional Head, 27mm x 46mm |
| 3 | 00-4301-052-18 | Provisional Head, 18mm x 52mm |
| | 00-4301-052-21 | Provisional Head, 21mm x 52mm |
| | 00-4301-052-24 | Provisional Head, 24mm x 52mm |
| | 00-4301-052-27 | Provisional Head, 27mm x 52mm |
| | 00-4301-052-30 | Provisional Head, 30mm x 52mm |

Kit 00-4300-000-15 Micro Stem Provisionals

- | | | |
|----------|----------------|-------------------------------|
| 4 | 00-4301-040-00 | Stem Provisional, 6mm x 60mm |
| | 00-4301-041-00 | Stem Provisional, 6mm x 130mm |
| | 00-4301-042-00 | Stem Provisional, 7mm x 60mm |

Kit 00-4300-000-16 Standard Stem Provisionals

- | | | |
|----------|----------------|--------------------------------|
| 5 | 00-4301-043-00 | Stem Provisional, 7mm x 130mm |
| | 00-4301-044-00 | Stem Provisional, 8mm x 130mm |
| | 00-4301-045-00 | Stem Provisional, 8mm x 170mm |
| | 00-4301-046-00 | Stem Provisional, 9mm x 130mm |
| | 00-4301-047-00 | Stem Provisional, 10mm x 130mm |
| | 00-4301-048-00 | Stem Provisional, 10mm x 170mm |
| | 00-4301-049-00 | Stem Provisional, 11mm x 130mm |
| | 00-4301-050-00 | Stem Provisional, 12mm x 130mm |
| | 00-4301-012-17 | Stem Provisional, 12mm x 170mm |
| | 00-4301-051-00 | Stem Provisional, 13mm x 130mm |
| | 00-4301-052-00 | Stem Provisional, 14mm x 130mm |
| | 00-4301-014-17 | Stem Provisional, 14mm x 170mm |
| | 00-4301-015-13 | Stem Provisional, 15mm x 130mm |
| | 00-4301-016-13 | Stem Provisional, 16mm x 130mm |

Kit 00-4300-000-14 Revision Stem Instrument

- | | |
|----------------|-------------------------------|
| 00-4301-076-00 | Stem Extractor (not pictured) |
|----------------|-------------------------------|

Case Layouts

Bigliani-Flatow The Complete Shoulder Solution Glenoid Top Tray Instruments

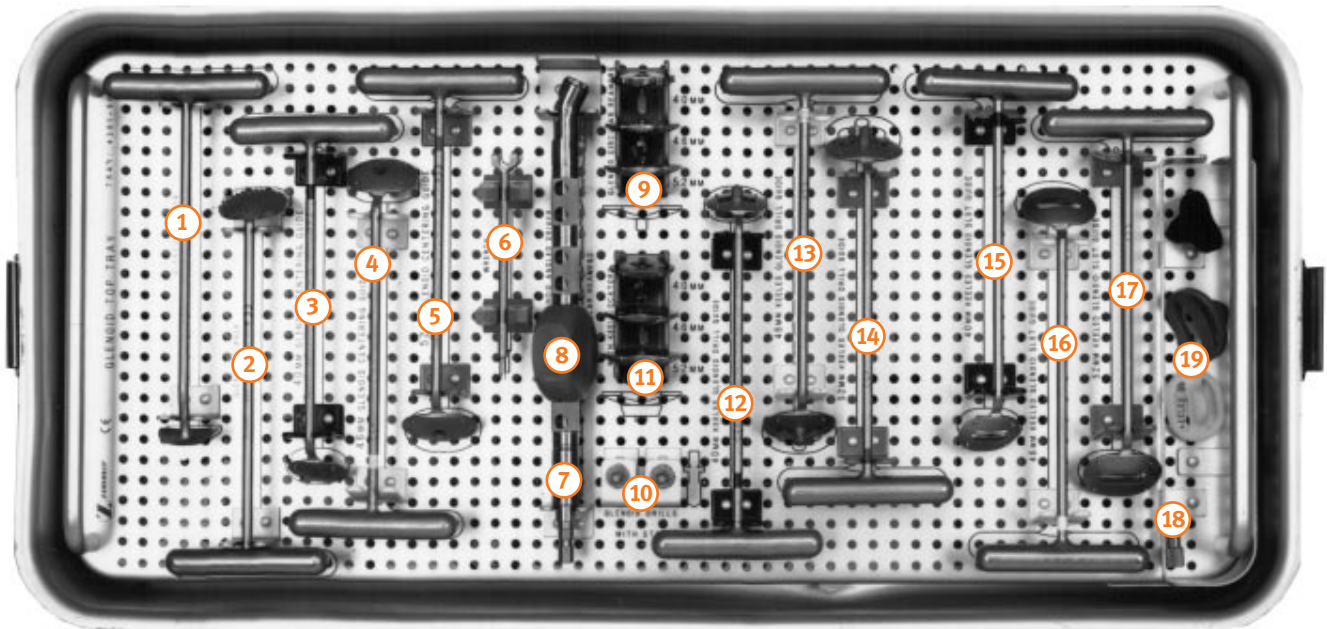

Kit 00-4300-000-18 Glenoid General Instruments

- 1 00-4301-018-00 Glenoid Scraper
- 2 00-4301-025-00 Glenoid Planer
- 3 00-4301-039-40 Glenoid Centering Guide, 40mm
- 4 00-4301-039-46 Glenoid Centering Guide, 46mm
- 5 00-4301-039-52 Glenoid Centering Guide, 52mm
- 6 00-4301-033-00 Wrench
- 7 00-4301-027-00 Angled Driver
- 8 00-4301-073-01 Palm Grip Assist
- 9 00-4301-028-40 Glenoid Circular Reamer, 40mm
- 00-4301-028-46 Glenoid Circular Reamer, 46mm
- 00-4301-028-52 Glenoid Circular Reamer, 52mm
- 10 00-4301-031-00 Glenoid Drills w/Stop, Sterile

Kit 00-4300-000-19 Glenoid with Keel Instruments

- 11 00-4301-029-40 Glenoid Circular Reamer, Keel Locator, 40mm
- 00-4301-029-46 Glenoid Circular Reamer, Keel Locator, 46mm
- 00-4301-029-52 Glenoid Circular Reamer, Keel Locator, 52mm
- 12 00-4301-030-40 Keeled Glenoid Drill Guide, 40mm
- 13 00-4301-030-46 Keeled Glenoid Drill Guide, 46mm
- 14 00-4301-030-52 Keeled Glenoid Drill Guide, 52mm
- 15 00-4301-026-40 Keeled Glenoid Slot Guide, 40mm
- 16 00-4301-026-46 Keeled Glenoid Slot Guide, 46mm

- 17 00-4301-026-52 Keeled Glenoid Slot Guide, 52mm
- 18 00-4301-031-01 Antirotation Pin (Optional)*

Kit 00-4300-000-21 Glenoid with Keel Provisionals

- 19 00-4301-063-00 Keeled Glenoid Provisional, 40mm
- 00-4301-064-00 Keeled Glenoid Provisional, 46mm
- 00-4301-065-00 Keeled Glenoid Provisional, 52mm
- 00-4301-040-46 Keeled Glenoid Provisional, 40mm x 46mm Articular Surface
- 00-4301-046-40 Keeled Glenoid Provisional, 46mm x 40mm Articular Surface
- 00-4301-046-52 Keeled Glenoid Provisional, 46mm x 52mm Articular Surface
- 00-4301-052-46 Keeled Glenoid Provisional, 52mm x 46mm Articular Surface
- 00-4301-052-56 Keeled Glenoid Provisional, 52mm x 56mm Articular Surface

*Must be ordered separately

Case Layouts

Bigliani-Flatow The Complete Shoulder Solution Glenoid Bottom Tray Instruments

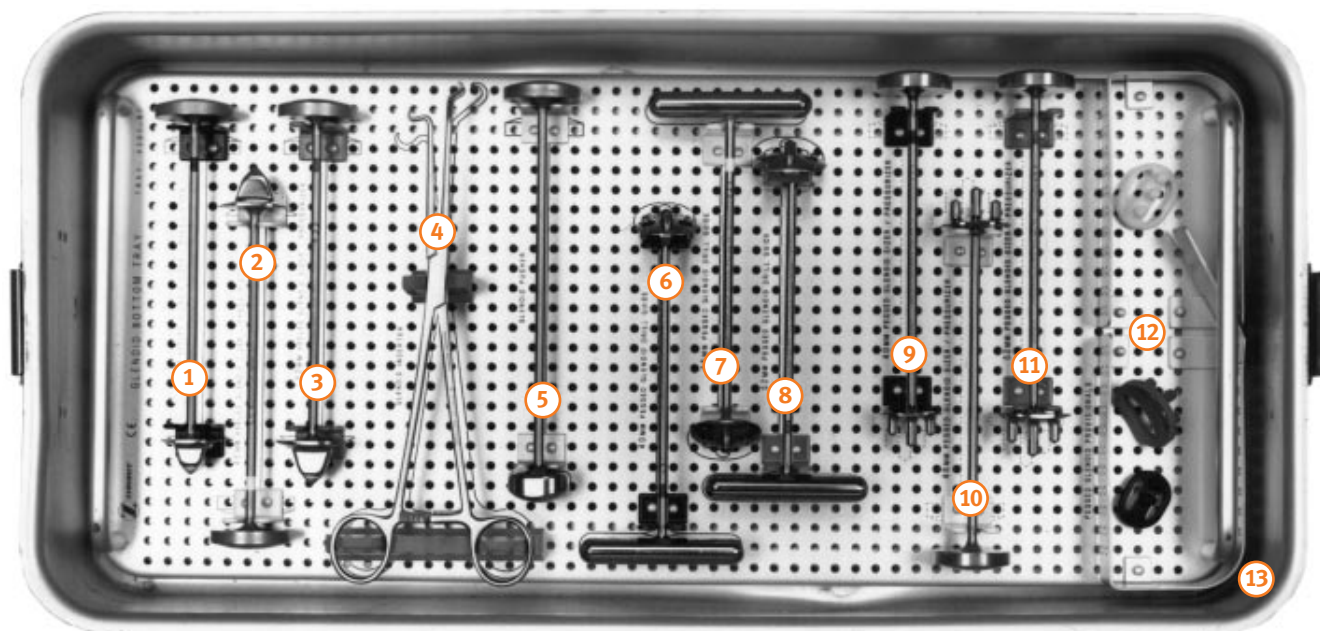

Kit 00-4300-000-19 Glenoid with Keel Instruments

- 1 00-4301-032-40 Keeled Glenoid Sizer/Pressurizer, 40mm
- 2 00-4301-032-46 Keeled Glenoid Sizer/Pressurizer, 46mm
- 3 00-4301-032-52 Keeled Glenoid Sizer/Pressurizer, 52mm

Kit 00-4300-000-18 Glenoid General Instruments

- 4 00-4301-037-00 Glenoid Inserter
- 5 00-4301-038-00 Glenoid Pusher

Kit 00-4300-000-20 Glenoid with Pegs Instruments

- 6 00-4301-077-40 Pegged Glenoid Drill Guide, 40mm
- 7 00-4301-077-46 Pegged Glenoid Drill Guide, 46mm
- 8 00-4301-077-52 Pegged Glenoid Drill Guide, 52mm
- 9 00-4301-036-40 Pegged Glenoid Sizer/Pressurizer, 40mm
- 10 00-4301-036-46 Pegged Glenoid Sizer/Pressurizer, 46mm
- 11 00-4301-036-52 Pegged Glenoid Sizer/Pressurizer, 52mm

Kit 00-4300-000-22 Glenoid with Pegs Provisionals

- 12 00-4301-066-40 Pegged Glenoid Provisional, 40mm
- 00-4301-067-40 Pegged Glenoid Provisional, 46mm
- 00-4301-068-40 Pegged Glenoid Provisional, 52mm
- 00-4303-040-46 Pegged Glenoid Provisional, 40mm x 46mm Articular Surface
- 00-4303-046-40 Pegged Glenoid Provisional, 46mm x 40mm Articular Surface
- 00-4303-046-52 Pegged Glenoid Provisional, 46mm x 52mm Articular Surface
- 00-4303-052-46 Pegged Glenoid Provisional, 52mm x 46mm Articular Surface
- 00-4303-052-56 Pegged Glenoid Provisional, 52mm x 56mm Articular Surface
- 13 00-4301-095-00 Glenoid Instrument/Provisional Case (empty)
(includes lid, two tray inserts, and base)

Case Layouts

Bigliani-Flatow Expanded Head Provisional Set 00-4300-000-24

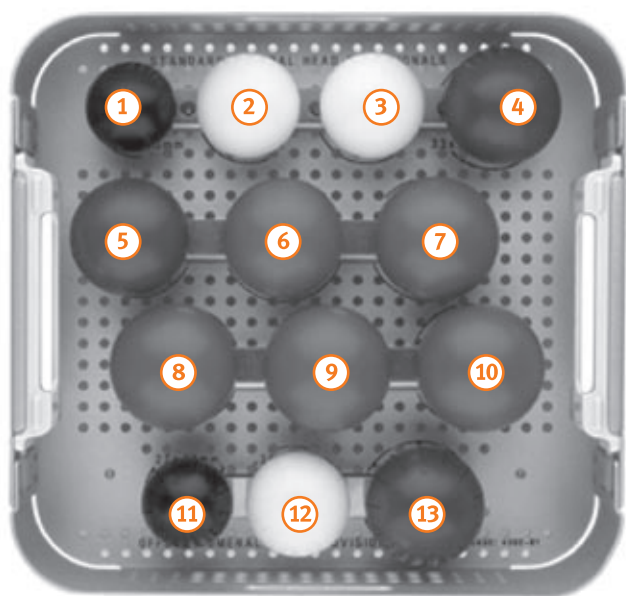

- 1 00-4301-040-27 Provisional Head 27mm x 40mm
- 2 00-4301-046-30 Provisional Head 30mm x 46mm
- 3 00-4301-046-33 Provisional Head 33mm x 46mm
- 4 00-4301-052-33 Provisional Head 33mm x 52mm
- 5 00-4301-052-36 Provisional Head 36mm x 52mm
- 6 00-4301-056-30 Provisional Head 30mm x 56mm
- 7 00-4301-056-33 Provisional Head 33mm x 56mm
- 8 00-4301-056-36 Provisional Head 36mm x 56mm
- 9 00-4301-056-39 Provisional Head 39mm x 56mm
- 10 00-4301-056-42 Provisional Head 42mm x 56mm
- 11 00-4303-040-27 Offset Humeral Head Provisional 27mm x 40mm
- 12 00-4303-046-30 Offset Humeral Head Provisional 30mm x 46mm
- 13 00-4303-052-33 Offset Humeral Head Provisional 33mm x 52mm

00-4302-090-00 Provisional Head Line Extension Case (empty)
Includes lid and tray

Bigliani-Flatow 17/18 Humeral Stem Set 00-4300-000-25

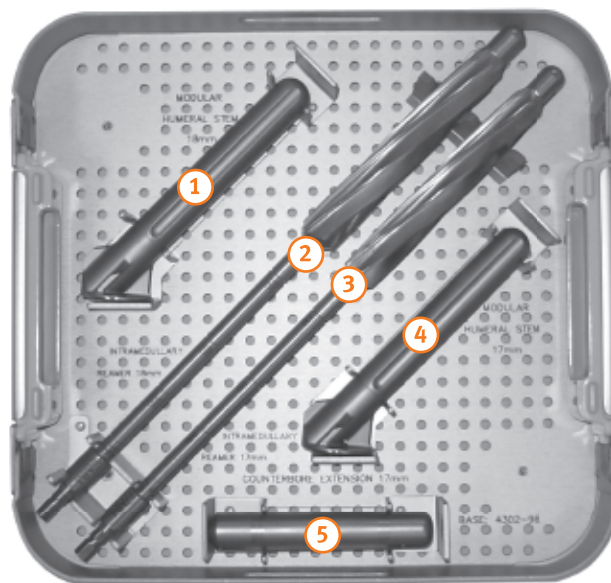

- 1 00-4301-018-13 Stem Provisional 18mm x 130mm
- 2 00-4301-000-18 Intramedullary Reamer, 18mm
- 3 00-4301-000-17 Intramedullary Reamer, 17mm
- 4 00-4301-017-13 Stem Provisional 17mm x 130mm
- 5 00-4301-074-17 17mm Counterbore Extension

00-4302-095-00 Size 17-18mm Line Extension Case (empty)
Includes lid and tray

The following sets are not included in *Bigliani/Flatow* Humeral General Instrument set but can be ordered separately using the following set numbers or individual component numbers.

Bigliani/Flatow Fracture Instrument Set (00-4304-000-00)

Offset Head Instrument Set (00-4302-000-11)

Offset Head Provisional Set (00-4302-000-12)

Standard Head Provisional Set (00-4300-000-17)

Bigliani/Flatow Fracture Sleeves (00-4304-007-00)







Please refer to the package inserts for complete product information, including contraindications, warnings, precautions and adverse effects.

Contact your Zimmer representative or visit us at www.zimmer.com



+H124974301103001/\$080812B09/